

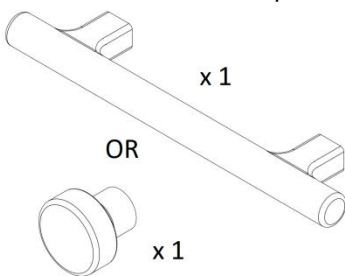

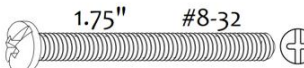

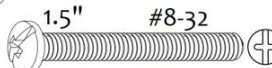

ALLENGLADE Knob/Pull

⚠ CALIFORNIA PROPOSITION 65 WARNING: This product can expose you to chemicals including Lead which is known to the State of California to cause cancer and birth defects or other reproductive harm. For more information go to <https://www.p65warnings.ca.gov/>

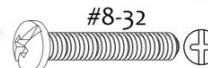
FASTENERS INCLUDED:

- **Knob:** (1) of each length: 1" / 1-1/2" / 1-3/4" #8-32 Truss head Phillips-Slotted drive screw
- **Pull:** (2) of each length: 1" / 1-1/2" / 1-3/4" #8-32 Truss head Phillips-Slotted drive screw

PARTS INCLUDED / PIÈCES INCLUSES / PARTES INCLUIDAS			TOOLS/ OUTILS/ HERRAMIENTAS		
	x 1			knob: x 1	pull: x 2
OR				x 1	x 2
	x 1			x 1	x 2
			  		
			NOT INCLUDED / NON INCLUS / NO INCLUIDAS		

MOUNTING INSTRUCTIONS: This knob/Pull includes hardware that is designed to mount securely to drawer-fronts or cabinet doors that have a thickness range between 1/2" and 1-1/2" inches. If your drawer-front or door is thicker or thinner than this range, please obtain the appropriate size screw from your local hardware store.

- **Knob:** Carefully determine a desired knob location and use a 3/16inch diameter drill bit and an appropriate drill to make the hole through the drawer/door front. Insert the appropriate length screw. Attach the knob onto the protruding threads of the screw and rotate clockwise until snug. Use a screwdriver to tighten the screw while gently holding the knob.
- **Pull:** Carefully determine a desired pull location. Use 3/16 inch diameter drill bit and appropriate drill to make the holes through the drawer-front / door with the proper center-to-center distance matching your pulls. Insert the appropriate length screws from the back of the drawer-front / door. Attach the drawer pull onto the protruding threads of the screws. Use a screwdriver to tighten the screws while gently holding the drawer pull.

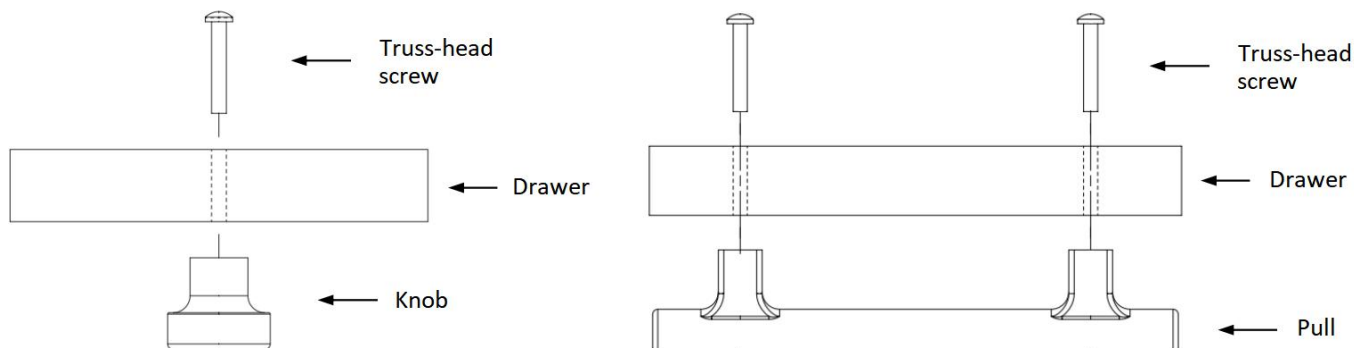

CLEANING INSTRUCTIONS

- Dust often using a clean, soft, dry and lint-free cloth.
- Blot spills and wipe with a clean, damp cloth immediately.
- We do not recommend the use of chemical cleansers, abrasive or furniture polish on our lacquered finish.
- Hardware may loosen over time. Periodically check to make sure all connections are tight. Re-tighten if necessary.