

SPECIFICATIONS

**RHAPSODY**

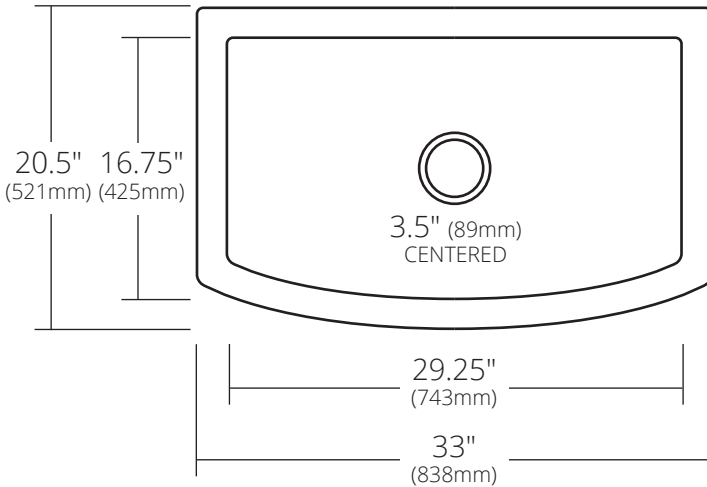

TOP VIEW



FRONT VIEW

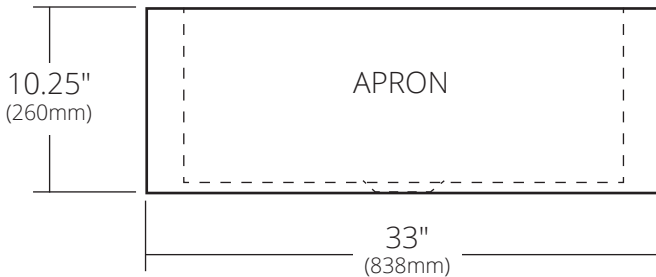

SIDE VIEW

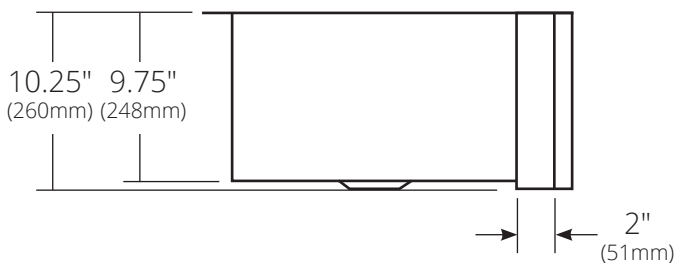

- CPK295 Antique
- CPK595 Brushed Nickel
- CPK495 Polished Copper
- CPK895 Polished Nickel

**PRODUCT DETAILS**

- 33" x 20.5" x 10.25" OD (838mm x 521mm x 260mm)
- 29.25" x 16.75" x 9.75" (743mm x 425mm x 248mm)
- Hand hammered, 16 gauge recycled copper
- Apron extends 2" on sides
- 3.5" (89mm) Drain opening

**INSTALLATION**

- Undermount

**COORDINATING PRODUCTS**

- Drains: DR320 or DR340
- Bottom Grid: GR2715
- MetalProtect® for polished finishes

**STANDARDS COMPLIANCE**

- UPC/cUPC compliant

**IMPORTANT**

Due to the handcrafted nature of this product, it will vary in finish, texture, hammering, and other details. Dimensions may vary up to 1/4" (6mm). We strongly recommend waiting for the actual product before making any installation cuts.

## BASIN INSTALLATION INSTRUCTIONS

### TABLE OF CONTENTS

- A. General Installation Notes
- B. Drop-In & Raised Profile Sink Installation
- C. Undermount Sink Installation
- D. Vessel Sink Installation
- E. Apron Front Sink Installation

[nativetrailshome.com](http://nativetrailshome.com)

### C. UNDERMOUNT SINK INSTALLATION:

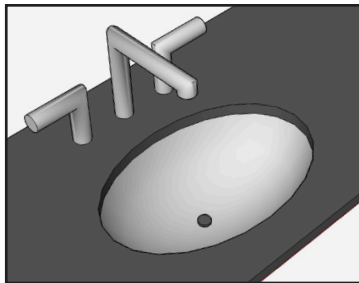

*If countertop is pre-cut go to Step 4.*

1. Use actual basin as your template. Place it upside down on countertop and mark countertop by tracing edge of basin. Be sure to allow clearance for faucet and other accessories or fixtures.
2. Measure inside edge of lip and mark countertop accordingly, inside of the first line.
3. Cut countertop on inside line.
4. Temporarily place basin under cut-out to verify proper fit of sink.
5. Apply silicone. Adhere to underside of counter top.
- 6a. For copper sinks: Mounting clip fasteners may be used to secure basin under countertop if desired.
- 6b. For NativeStone or Precious Metals Collection sinks: We recommend Native Trails Sink Undermount Kits available in large and small. Choose the size that works with your application and follow the instructions included with the kits. Please consult with your installer to determine which system would best fit your needs.
7. Carefully remove any excess silicone.
8. Install the drain according to the drain's installation instructions.  
**Do not over tighten**

### A. READ THIS FIRST GENERAL INSTALLATION NOTES:

- All Native Trails products should be installed by a licensed contractor.
- Observe and comply with all building and plumbing codes.
- As our basins are handcrafted and dimensions are approximate, we recommend using the actual basin for any cutouts.
- Use 100% Silicone (non-water based) for all installations.
- Ensure adequate space behind the basin for faucet and backsplash, including the full range of motion for faucet handles and spouts.
- Make sure a watertight seal exists on all drain connections.
- Do not place basin directly on floor. After unpacking, place basin on protective material such as packing materials.
- Remember to always use non-abrasive cleaners on Native Trails sinks and tubs. Mild soap and water is recommended. Refer to Care and Cleaning Instructions for further information.
- If unsure which instructions pertain to your product call our Customer Service Department at 800.786.0862. You may also view Installation and Care and Cleaning Instructions at [nativetrailshome.com](http://nativetrailshome.com).

**CAUTION: Risk of personal injury. Large sinks can be extremely heavy. Obtain sufficient help to carefully lift or move.**

### D. VESSEL SINK INSTALLATION:

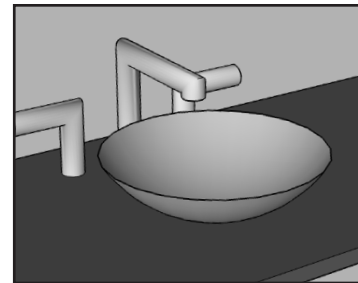

*If countertop is pre-cut go to Step 3.*

1. From the underside, measure outside perimeter of sink's drain flange and mark countertop.
2. Cut countertop for drain flange opening.
3. Temporarily place basin on top of countertop and verify that the sink's drain flange sits down properly inside of the countertop hole, so bottom of vessel is flush with the countertop.
4. Turn your sink upside down and place on a soft surface. Apply a thin bead of silicone where the basin will meet the countertop.
5. Set sink into place on countertop. Install the drain according to the drain's installation instructions.  
**Do not over tighten**
6. Depending on the size of the hole in the countertop, it may be necessary to use a large washer with the drain to secure the basin to the countertop.
7. If installing a vessel with a flat bottom, a bead of silicone can be used to seal the vessel to the countertop, if desired.
8. Carefully remove any excess silicone.

### B. DROP-IN & RAISED PROFILE SINK INSTALLATION:

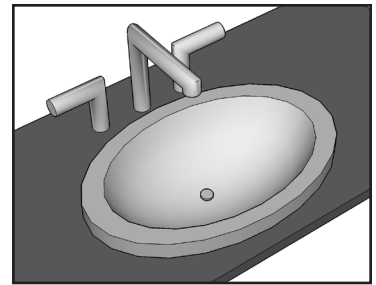

*If countertop is pre-cut go to Step 4.*

1. Use actual basin as your template. Place it upside down on countertop and mark countertop by tracing edge of basin. Be sure to allow clearance for faucet and other accessories or fixtures.
2. Measure inside edge of lip and mark countertop accordingly, inside of the first tracing made.
3. Cut countertop midway in-between the two lines.
4. Temporarily place basin in cut-out to verify proper fit.
5. Apply silicone around cut-out in countertop, and place basin in cut-out.
- 6a. For copper raised profile sinks: Use wood screws from underneath the countertop and screw into wood blocks or use silicone on wood blocks to adhere/secure to countertop. Make sure that the screws align with the wood blocks. If the screws are not placed properly, damage to the copper may occur.
- 6b. For NativeStone® or Precious Metals Collection raised profile sinks: apply silicone to underside of rim and press into place.
7. Use a level to ensure that the basin is sitting level in all directions, front to back and side to side while pressing down to seal.
8. Carefully remove any excess silicone.
9. Install the drain according to the drain's installation instructions.  
**Do not over tighten**

### E. APRON FRONT SINK INSTALLATION:

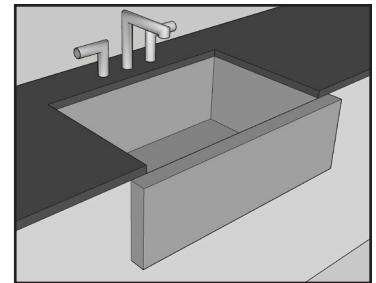

1. Use your actual sink as your template. Measure outside dimensions of basin and mark your cabinet accordingly for apron cutout.
2. Cut cabinet on marked line.
3. We recommend Native Trails Sink Undermount Kits available in large and small. Choose the size that works with your application and follow the instructions included with the kits. Please consult with your installer to determine which system would best fit your needs.
4. Place your sink in cabinet opening making sure it's flush with the top of the cabinet and sits level.
5. Measure inside dimensions of basin and mark countertop accordingly.
6. Cut countertop. Apply a bead of silicone around the top edge of the sink and install countertop.
7. Apply silicone to fill any visual gaps between sink and countertop as well as cabinet.
8. Carefully remove any excess silicone.
9. Install the drain according to the drain's installation instructions.  
**Do not over tighten**